

**Component
Image & Dimension**

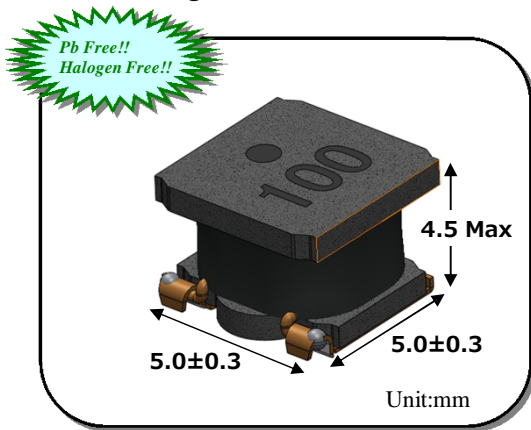

Features :

- a) Miniature Size :
Mount Area : 5.0mm x 5.0mm
4.5mm Max. Height
- b) Generic use for DC/DC Converter Line.
- c) Automatic Mounting in Tape & Reel Package.

Recommended Land Pattern

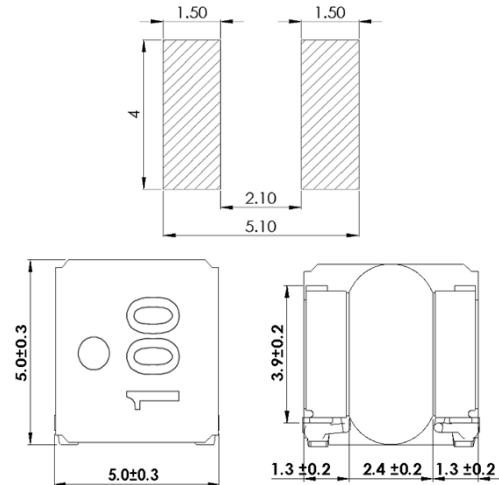

Applications :

DC-DC Converter for Note-PC, Monitor etc.

Electrical Specification

TDK Identification	Inductance (uH)	Tol. (%)	Test Freq. (kHz)	DC Resistance		Rated DC Current	
				Typ. (Ohm)	Tol. (%)	* Idc1 (A max.)	* Idc2 (A typ.)
VLS5045EX- 1R0N	1.0	+/-30%	100	0.015	+/-30%	8.9	5.1
VLS5045EX- 1R5N	1.5	+/-30%	100	0.017	+/-30%	7.4	5.0
VLS5045EX- 1R8N	1.8	+/-30%	100	0.019	+/-30%	7.0	4.8
VLS5045EX- 2R2N	2.2	+/-30%	100	0.022	+/-30%	6.4	4.7
VLS5045EX- 3R3N	3.3	+/-30%	100	0.027	+/-30%	5.2	4.2
VLS5045EX- 4R7M	4.7	+/-20%	100	0.036	+/-30%	4.4	3.2
VLS5045EX- 6R8M	6.8	+/-20%	100	0.046	+/-30%	3.6	2.9
VLS5045EX- 8R2M	8.2	+/-20%	100	0.055	+/-30%	3.3	2.8
VLS5045EX- 100M	10	+/-20%	100	0.061	+/-30%	3.1	2.5
VLS5045EX- 150M	15	+/-20%	100	0.110	+/-30%	2.2	1.9
VLS5045EX- 220M	22	+/-20%	100	0.125	+/-30%	2.0	1.8
VLS5045EX- 330M	33	+/-20%	100	0.240	+/-30%	1.5	1.3
VLS5045EX- 470M	47	+/-20%	100	0.300	+/-30%	1.3	1.0
VLS5045EX- 680M	68	+/-20%	100	0.410	+/-30%	1.1	0.9
VLS5045EX- 101M	100	+/-20%	100	0.580	+/-30%	0.8	0.7

Note)

* Idc1 : Depend on inductance change (-30% reduction from initial value)

* Idc2 : Depend on self temperature rise (40degC typical)

Operating Temperature Range : -40deg.C ~ +105deg.C(Including Self Temp.Rise)

VLS5045EX Type

Idc1:Inductance vs. DC Superposition Characteristics(Ref)

Idc2:Temp.Rise(Ref)

TDK' PartNo.;VLS5045EX-1R0N

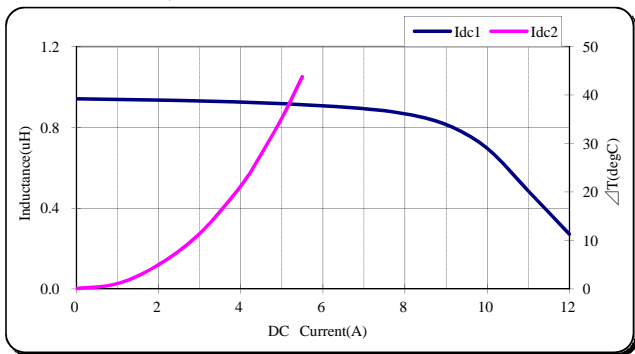

TDK' PartNo.;VLS5045EX-1R5N

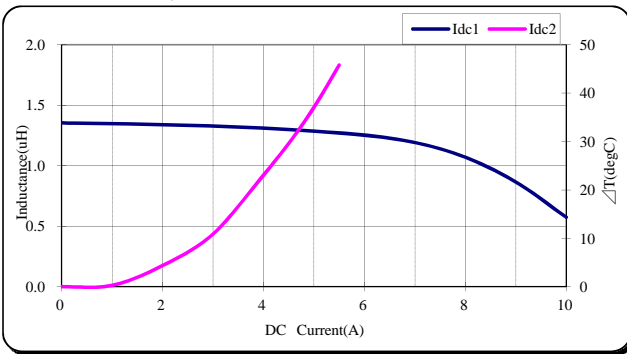

TDK' PartNo.;VLS5045EXT-1R8N

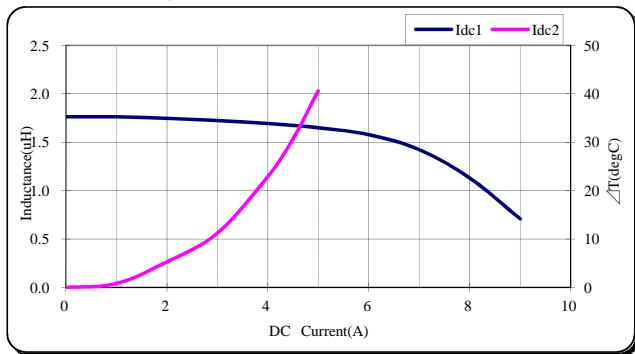

TDK' PartNo.;VLS5045EX-2R2N

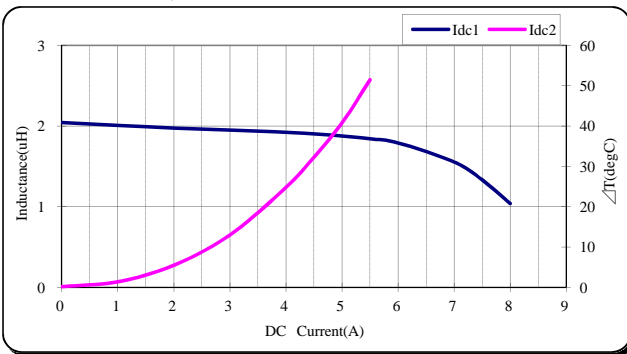

TDK' PartNo.;VLS5045EX-3R3N

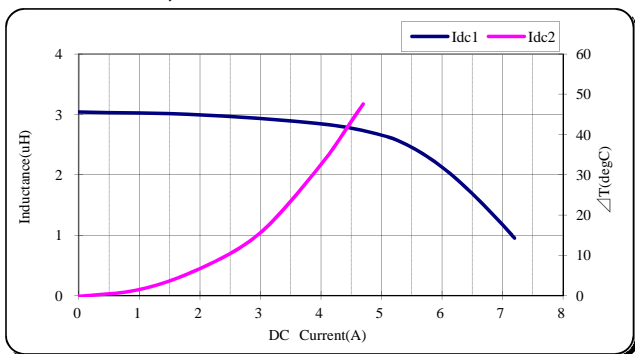

TDK' PartNo.;VLS5045EX-4R7M

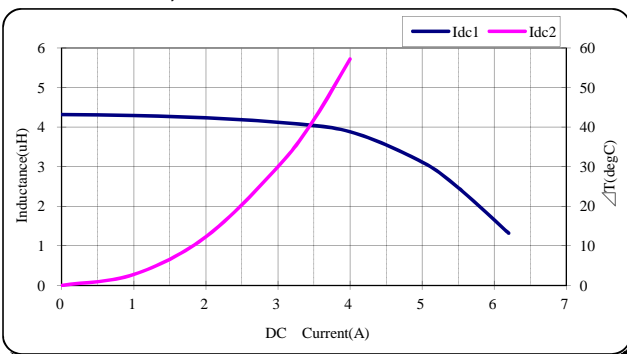

TDK' PartNo.;VLS5045EX-6R8M

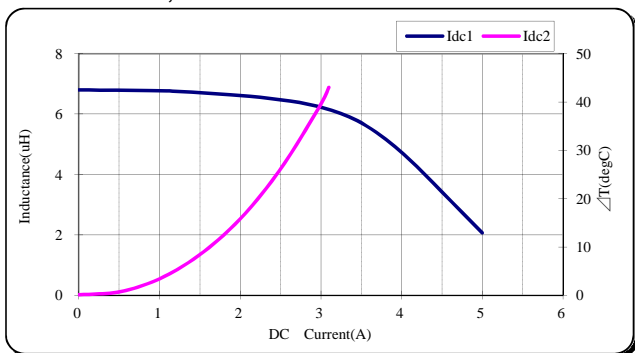

TDK' PartNo.;VLS5045EX-8R2M

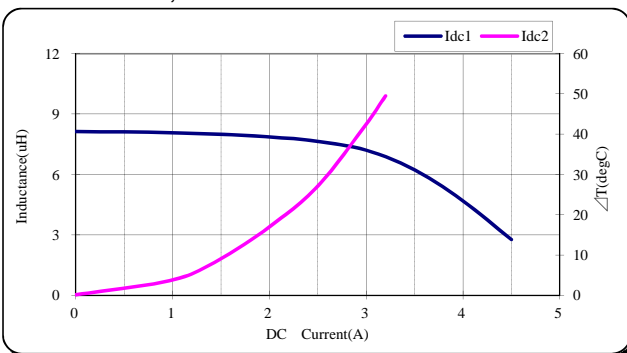

TDK' PartNo.;VLS5045EX-100M

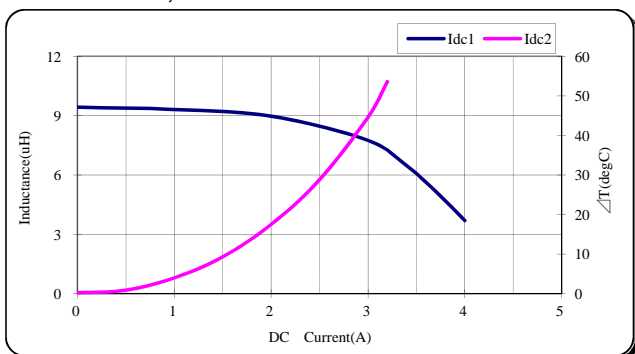

TDK' PartNo.;VLS5045EX-150M

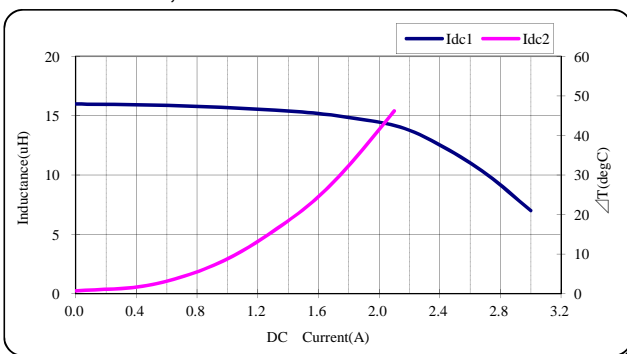

TDK' PartNo.;VLS5045EX-220M

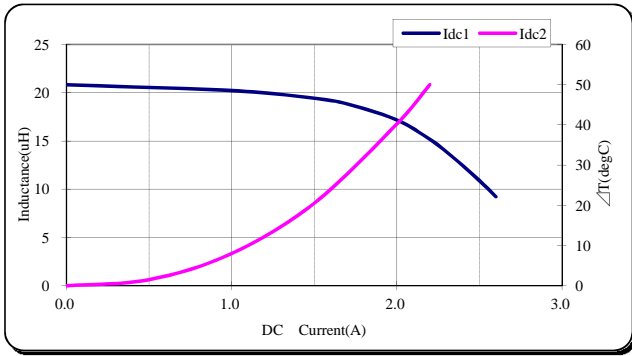

TDK' PartNo.;VLS5045EX-330M

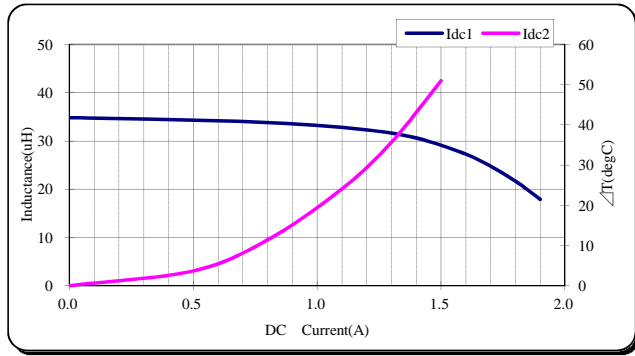

TDK' PartNo.;VLS5045EX-470M

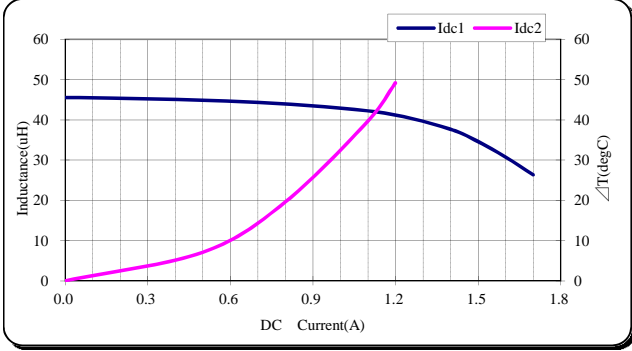

TDK' PartNo.;VLS5045EX-680M

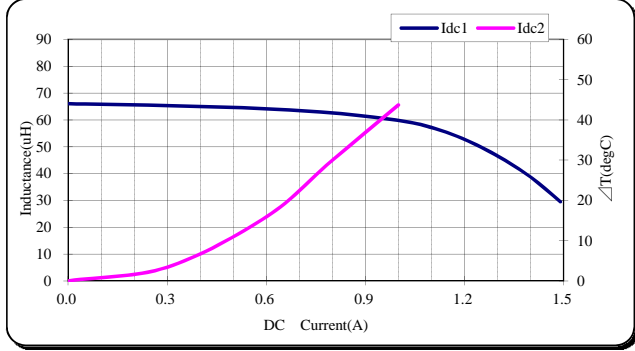

TDK' PartNo.;VLS5045EX-101M

